

**SIRUBA®**

銀爺牌工業用縫紉機

INDUSTRIAL SEWING MACHINE

**700K**

## 零件圖 PARTS LIST



CE











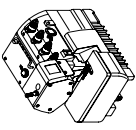

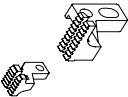
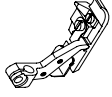

高林股份有限公司  
KAULIN MFG. CO., LTD.

機 型 MODEL	針板 NEEDLE PLATE	送具 FEED DOG	送具 FEED DOG	送具 FEED DOG	押具 PRESSER FOOT	勾針 LOOPER	針留 NEEDLE CLAMP	束子 COLLER	衝程 CRANK	衝程 CRANK	大心 Crankshaft	勾針連桿座 Upper Looper Holder	過線器 Bracket	下刀架 Lower Knife Holder	針 號 NEEDLE
737K-504F1-04	E206	D201	D207	H201	P201-4A	LP225	KG231K-E	KJ204	KF203-E	KJ206-E	KD201	KJ236	KJ219	KR209	DC27#9
737K-504M1-15	E207	D201	D209	H201	P211-A	LP225	KG231K-E	KJ204	KF203-E	KJ206-E	KD201	KJ236	KJ219	KR209	DC27#9
737K-504M1-15VT	E207	D201	D209	H201	P211-A	LP225	KG231K-E	KJ204	KF203-E	KJ206-E	KD201	KJ236	KJ219	KR209	DC27#9
737K-504M2-04	E222	D210	D207	H204	P201-A	LP225	KG231K-E	KJ204	KF203-E	KJ206-E	KD201	KJ236	KJ219	KR209	DC27#11
737K-504M2-04CT	E222	D210	D207	H204	P201-A	LP225	KG231K-E	KJ204	KF203-E	KJ206-E	KD201	KJ236	KJ219	KR209	DC27#11
737K-504M2-04EC	E222	D210	D207	H204	P201-A	LP225	KG231K-E	KJ204	KF203-E	KJ206-E	KD201	KJ236	KJ219	KR209	DC27#11
737K-504M2-04LFC-2	E222	D210	D207	H204	P215-A	LP225	KG231K-E	KJ204	KF203-E	KJ206-E	KD201	KJ236	KJ219	KR209	DC27#11
737K-504M2-04LFC-2/EC	E222	D210	D207	H204	P215-A	LP225	KG231K-E	KJ204	KF203-E	KJ206-E	KD201	KJ236	KJ219	KR209	DC27#11
737K-504M2-04TR	E231	D210	D214	H204	P215-A	LP225	KG231K-E	KJ204	KF203-E	KJ206-E	KD201	KJ236	KJ219	KR209	DC27#11
737K-504M2-04TR/EC	E231	D210	D214	H204	P215-A	LP225	KG231K-E	KJ204	KF203-E	KJ206-E	KD201	KJ236	KJ219	KR209	DC27#11
737K-504M2-04VT	E222	D210	D207	H204	P201-A	LP225	KG231K-E	KJ204	KF203-E	KJ206-E	KD201	KJ236	KJ219	KR209	DC27#11
737K-504M2-04WR/LF-B	E231					LP225	KG231K-E	KJ204	KF203-E	KJ206-E	KD201	KJ236	KJ219	KR209	DC27#11
737K-504M3-04	E220	D210	D209	H204	P201-A	LP225	KG231K-E	KJ204	KF203-E	KJ206-E	KD201	KJ236	KJ219	KR209	DC27#11
737K-504M3-05	E221	D210	D209	H204	P201-A	LP225	KG231K-E	KJ204	KF203-E	KJ206-E	KD201	KJ236	KJ219	KR209	DC27#11
737K-504M3-05CT	E221	D210	D209	H204	P201-A	LP225	KG231K-E	KJ204	KF203-E	KJ206-E	KD201	KJ236	KJ219	KR209	DC27#11
737K-504M3-05PZ	E221	D210	D209	H204	P216-A	LP225	KG231K-E	KJ204	KF203-E	KJ206-E	KD201	KJ236	KJ219	KR209	DC27#11
737K-504M3-05VT	E221	D210	D209	H204	P201-A	LP225	KG231K-E	KJ204	KF203-E	KJ206-E	KD201	KJ236	KJ219	KR209	DC27#11
737K-504M5-04BK	E232	D210	D207	H203	P202-A	LP225	KG231K-E	KJ204	KF203-E	KJ206-E	KD201	KJ236	KJ219	KR209	DC27#11
737K-504M5-04BK/VT	E232	D210	D207	H203	P202-A	LP225	KG231K-E	KJ204	KF203-E	KJ206-E	KD201	KJ236	KJ219	KR209	DC27#11
737K-504F1-15	E207	D201	D209	H201	P203-A	LP225	KG231K-E	KJ204	KF203-E	KJ206-E	KD201	KJ236	KJ219	KR209	DC27#9
737K-505F1-04	E206	D201	D207	H201	P203-A	LP225	KG231K-E	KJ204	KF203-E	KJ206-E	KD201	KJ236	KJ219	KR209	DC27#9
737K-505F1-04VT	E206	D201	D207	H201	P203-A	LP225	KG231K-E	KJ204	KF203-E	KJ206-E	KD201	KJ236	KJ219	KR209	DC27#9
747K-512M1-25	E208	D210	D207	H204	P201-5A	LP228	KG242K-E	KJ234+KL15	KF215-E	KJ203-E	KD201	KJ208	KJ219	KR209	DC27#11*2
747K-512M1-25CT	E208	D210	D207	H204	P201-5A	LP228	KG242K-E	KJ234+KL15	KF215-E	KJ203-E	KD201	KJ208	KJ219	KR209	DC27#11*2
747K-512M1-34	E236	D210	D207	H204	P221-A	LP226	KG243K-E	KJ234+KL15	KF203-E	KJ203-E	KD201	KJ208	KJ219	KR209	DC27#14*2
747K-514F1-24	E212	D210	D207	H204	P201-3A	LP229	KG242K-E	KJ204	KF203-E	KJ206-E	KD201	KJ236	KJ219	KR209	DC27#11*2
747K-514H4-24CA	E229	D202	D207	H202	P204-A	LP226	KG242K-E	KJ234+KL15	KF203-E	KJ203-E	KD201	KJ208	KJ219	KR209	DC27#11*2
747K-514H4-24CA/CT	E229	D202	D207	H202	P204-A	LP226	KG242K-E	KJ234+KL15	KF203-E	KJ203-E	KD201	KJ208	KJ219	KR209	DC27#11*2
747K-514H4-24GA/EC	E229	D202	D207	H202	P204-A	LP226	KG242K-E	KJ234+KL15	KF203-E	KJ203-E	KD201	KJ208	KJ219	KR209	DC27#11*2
747K-514H4-24GA/P	E229	D202	D207	H202	P204-A	LP226	KG242K-E	KJ234+KL15	KF203-E	KJ203-E	KD201	KJ208	KJ219	KR209	DC27#11*2
747K-514M2-24	E229	D210	D207	H204	P201-A	LP226	KG242K-E	KJ234+KL15	KF203-E	KJ203-E	KD201	KJ208	KJ219	KR209	DC27#11*2
747K-514M2-24CT	E229	D210	D207	H204	P201-A	LP226	KG242K-E	KJ234+KL15	KF203-E	KJ203-E	KD201	KJ208	KJ219	KR209	DC27#11*2
747K-514M2-24EC	E229	D210	D207	H204	P201-A	LP226	KG242K-E	KJ234+KL15	KF203-E	KJ203-E	KD201	KJ208	KJ219	KR209	DC27#11*2

## 規格件表 CONVERSION CHART

# 規格件表 CONVERSION CHART

												
機 型 MODEL	針板 NEEDLE PLATE	送具 FEED DOG	押具 PRESSER FOOT	勾 針 LOOPER	針留 NEEDLE CLAMP	束 子 COLLER	衝 程 CRANK	衝 程 CRANK	勾針連焊座 Upper Looper Holder	過線器 Bracket	下刀架 Lower Knife Holder	針 號 NEEDLE
747K-514M2-24LFC-2	E229	D210	P216-A	LP225	KG242K-E	KJ234+KLL15	KF203-E	KF203-E	KJ208	KJ219	KR209	DC27#11*2
747K-514M2-24LFC-2/EC	E229	D210	P216-A	LP226	KG242K-E	KJ234+KLL15	KF203-E	KF203-E	KJ208	KJ219	KR209	DC27#11*2
747K-514M2-24TG	E229	D210	P201-A	LP226	KG242K-E	KJ234+KLL15	KF203-E	KF203-E	KJ208	KJ219	KR209	DC27#11*2
747K-514M2-24TG/EC	E229	D210	P201-A	LP226	KG242K-E	KJ234+KLL15	KF203-E	KF203-E	KJ208	KJ219	KR209	DC27#11*2
747K-514M2-24VT	E229	D210	P201-A	LP226	KG242K-E	KJ234+KLL15	KF203-E	KF203-E	KJ208	KJ219	KR209	DC27#11*2
747K-514M2-25	E208	D210	P201-A	LP226	KG242K-E	KJ234+KLL15	KF203-E	KF203-E	KJ208	KJ219	KR209	DC27#11*2
747K-514M2-25CT	E208	D210	P201-A	LP226	KG242K-E	KJ234+KLL15	KF203-E	KF203-E	KJ208	KJ219	KR209	DC27#11*2
747K-514M2-25TG	E208	D210	P201-A	LP226	KG242K-E	KJ234+KLL15	KF203-E	KF203-E	KJ208	KJ219	KR209	DC27#11*2
747K-514M4-23	E209	D210	P201-2A	LP226	KG242K-E	KJ234+KLL15	KF203-E	KF203-E	KJ208	KJ219	KR209	DC27#11*2
747K-514M4-23/CT	E209	D210	P201-2A	LP226	KG242K-E	KJ234+KLL15	KF203-E	KF203-E	KJ208	KJ219	KR209	DC27#11*2
747K-514M5-23BK	E210	D203	P202-A	LP226	KG242K-E	KJ234+KLL15	KF203-E	KF203-E	KJ208	KJ219	KR209	DC27#11*2
747K-514M5-23BK/VT	E210	D203	P202-A	LP226	KG242K-E	KJ234+KLL15	KF203-E	KF203-E	KJ208	KJ219	KR209	DC27#11*2
747K-514M7-23	E242	D218	P201-5A	LP227	KG242K-E	KJ234+KLL15	KF203-E	KF203-E	KJ228	KJ238	KR209	DC27#16*2
747K-514M7-23/CT	E242	D218	P201-5A	LP227	KG242K-E	KJ234+KLL15	KF203-E	KF203-E	KJ228	KJ238	KR209	DC27#16*2
747K-514M7-24	E243	D218	P201-5A	LP227	KG242K-E	KJ234+KLL15	KF203-E	KF203-E	KJ228	KJ238	KR209	DC27#16*2
747K-514M7-24CT	E243	D218	P201-5A	LP227	KG242K-E	KJ234+KLL15	KF203-E	KF203-E	KJ228	KJ238	KR209	DC27#16*2
747K-514M7-24TG	E243	D218	P201-5A	LP227	KG242K-E	KJ234+KLL15	KF203-E	KF203-E	KJ228	KJ238	KR209	DC27#16*2
747K-514M7-25	E244	D218	P201-5A	LP227	KG242K-E	KJ234+KLL15	KF203-E	KF203-E	KJ228	KJ238	KR209	DC27#16*2
747K-514M7-25/AN	E244	D218	P201-5A	LP227	KG242K-E	KJ234+KLL15	KF203-E	KF203-E	KJ228	KJ238	KR209	DC27#16*2
747K-514M7-25BK	E210	D203	P202-A	LP227	KG242K-E	KJ234+KLL15	KF203-E	KF203-E	KJ228	KJ238	KR209	DC27#16*2
747K-514M7-25BK/AN	E210	D203	P202-A	LP227	KG242K-E	KJ234+KLL15	KF203-E	KF203-E	KJ228	KJ238	KR209	DC27#16*2
747K-514M7-25CT	E244	D218	P201-5A	LP227	KG242K-E	KJ234+KLL15	KF203-E	KF203-E	KJ228	KJ238	KR209	DC27#16*2
747K-514M7-25TG	E244	D218	P201-5A	LP227	KG242K-E	KJ234+KLL15	KF203-E	KF203-E	KJ228	KJ238	KR209	DC27#16*2
747K-514M7-25TG/AN	E244	D218	P201-5A	LP227	KG242K-E	KJ234+KLL15	KF203-E	KF203-E	KJ228	KJ238	KR209	DC27#16*2
747K-514M8-35	E223	D212	P214-A	LP229	KG254K-E	KJ234+KLL15	KF203-E	KF203-E	KJ228	KJ238	KR211	DC27#18*2
747K-514M8-35CT	E223	D212	P214-A	LP229	KG254K-E	KJ234+KLL15	KF203-E	KF203-E	KJ228	KJ238	KR211	DC27#18*2
757K-401M1/TW	E237	D212	P215-A	LP226	KG242K-E	KJ204	KF203-E	KF203-E	KJ208	KJ219	KR219	DC27#14*2
757K-401M1/TW/CT	E237		P215-A	LP226	KG253K-E	KJ204	KF203-E	KF203-E	KJ236	KJ219	KR219	DC27#14*2
757K-401M2-50TA	E238	D211	P223-A	LP226	KG256K-E	KJ204	KF203-E	KF203-E	KJ236	KJ219	KR219	DC27#14*2
757K-401M2-50TA/EC	E238	D211	P223-A	LP226	KG256K-E	KJ204	KF203-E	KF203-E	KJ236	KJ219	KR219	DC27#14*2
757K-516H4-35GA	E213	D204	P508J-A	LP226	KG253K-E	KJ204	KF203-E	KF203-E	KJ236	KJ219	KR219	DC27#14*2
757K-516H4-35GA/EC	E213	D204	P508J-A	LP226	KG253K-E	KJ204	KF203-E	KF203-E	KJ236	KJ219	KR219	DC27#14*2
757K-516H4-35GA/P	E213	D204	P508J-A	LP226	KG253K-E	KJ204	KF203-E	KF203-E	KJ236	KJ219	KR219	DC27#14*2

機 型 MODEL	針板 NEEDLE PLATE	送具 FEED DOG	送具 FEED DOG	送具 FEED DOG	押具 PRESSER FOOT	勾針 LOOPER	針留 NEEDLE CLAMP	束子 COLLER	衝程 CRANK	衝程 CRANK	大心 Crankshaft	勾針連焊座 Upper Looper Holder	過線器 Bracket	下刀架 Lower Knife Holder	針號 NEEDLE
757K-516H4-35GA/P/EC	E213	D204	D207	H205	P508J-A	LP226	KG253K-E	KJ204	KF203-E	KJ206-E	KD201	KJ236	KJ219	KR219	DC27#14*2
757K-516H4-55GA	E214	D205	D207	H206	P509J-A	LP226	KG255K-E	KJ204	KF203-E	KJ206-E	KD201	KJ236	KJ219	KR219	DC27#14*2
757K-516H4-55GA/EC	E214	D205	D207	H206	P509J-A	LP226	KG255K-E	KJ204	KF203-E	KJ206-E	KD201	KJ236	KJ219	KR219	DC27#14*2
757K-516H4-55GA/P	E214	D205	D207	H206	P509J-A	LP226	KG255K-E	KJ204	KF203-E	KJ206-E	KD201	KJ236	KJ219	KR219	DC27#14*2
757K-516H4-55GA/P/EC	E214	D205	D207	H206	P509J-A	LP226	KG255K-E	KJ204	KF203-E	KJ206-E	KD201	KJ236	KJ219	KR219	DC27#14*2
757K-516L1-24	E215	D206	D207	H207	P500J-A	LP225	KG252K-E	KJ204	KF203-E	KJ206-E	KD201	KJ236	KJ219	KR219	DC27#14*2
757K-516L1-35	E215	D206	D207	H207	P500J-A	LP225	KG252K-E	KJ204	KF203-E	KJ206-E	KD201	KJ236	KJ219	KR219	DC27#14*2
757K-516L1-35CT	E216	D206	D207	H212	P504J-A	LP225	KG253K-E	KJ204	KF203-E	KJ206-E	KD201	KJ236	KJ219	KR219	DC27#14*2
757K-516M2-35	E216	D206	D207	H212	P504J-A	LP225	KG253K-E	KJ204	KF203-E	KJ206-E	KD201	KJ236	KJ219	KR219	DC27#14*2
757K-516M2-35CT	E217	D208	D207	H208	P504J-A	LP226	KG253K-E	KJ204	KF203-E	KJ206-E	KD201	KJ236	KJ219	KR219	DC27#14*2
757K-516M2-35CT	E217	D208	D207	H208	P504J-A	LP226	KG253K-E	KJ204	KF203-E	KJ206-E	KD201	KJ236	KJ219	KR219	DC27#14*2
757K-516M2-35PS	E217	D208	D207	H208	P504J-A	LP226	KG253K-E	KJ204	KF203-E	KJ206-E	KD201	KJ236	KJ219	KR219	DC27#14*2
757K-516M2-35PS/EC	E217	D208	D207	H208	P504J-A	LP226	KG253K-E	KJ204	KF203-E	KJ206-E	KD201	KJ236	KJ219	KR219	DC27#14*2
757K-516M2-55	E218	D208	D207	H209	P502J-A	LP226	KG255K-E	KJ204	KF203-E	KJ206-E	KD201	KJ236	KJ219	KR219	DC27#14*2
757K-516M2-55CT	E218	D208	D207	H209	P502J-A	LP226	KG255K-E	KJ204	KF203-E	KJ206-E	KD201	KJ236	KJ219	KR219	DC27#14*2
757K-516M2-55EC	E218	D208	D207	H209	P502J-A	LP226	KG255K-E	KJ204	KF203-E	KJ206-E	KD201	KJ236	KJ219	KR219	DC27#14*2
757K-516M2-55PS	E218	D208	D207	H209	P502J-A	LP226	KG255K-E	KJ204	KF203-E	KJ206-E	KD201	KJ236	KJ219	KR219	DC27#14*2
757K-516M2-55PS/EC	E218	D208	D207	H209	P502J-A	LP226	KG255K-E	KJ204	KF203-E	KJ206-E	KD201	KJ236	KJ219	KR219	DC27#14*2
767K-516M2-324	E219	D208	D207	H209	P233J-A	LP226	KG433K-E	KJ234+HL15	KF203-E	KJ203-E	KD201	KJ208	KJ219	KR219	DC27#11*3
767K-516M2-324/CT	E219	D208	D207	H209	P233J-A	LP226	KG433K-E	KJ234+HL15	KF203-E	KJ203-E	KD201	KJ208	KJ219	KR219	DC27#11*3
767K-516M2-524	E224	D208	D207	H209	P255J-A	LP226	KG455K-E	KJ234+HL15	KF203-E	KJ203-E	KD201	KJ208	KJ219	KR219	DC27#11*3
767K-516M2-524/CT	E224	D208	D207	H209	P255J-A	LP226	KG455K-E	KJ234+HL15	KF203-E	KJ203-E	KD201	KJ208	KJ219	KR219	DC27#11*3

# PARTS LIST FOR KA GROUP

# PARTS LIST FOR KB GROUP

MODEL	3線 / 4線	5線 / 6線
PARTS NO	KA224	

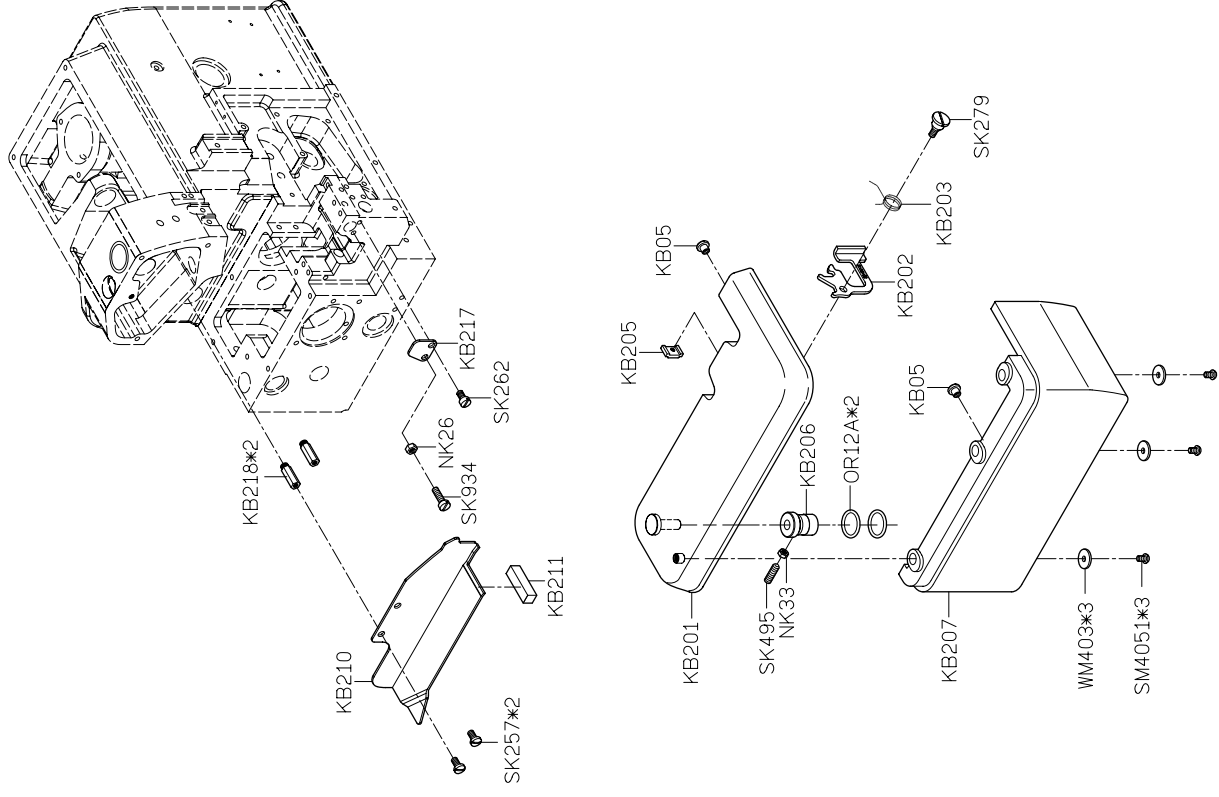
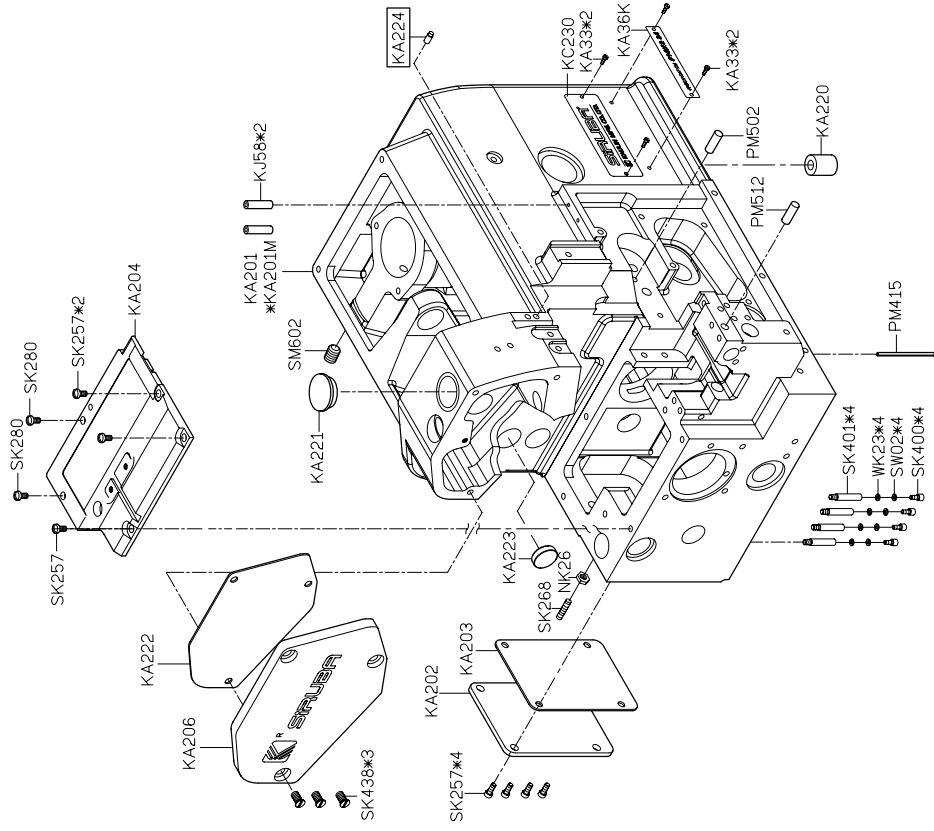



FOR 700K

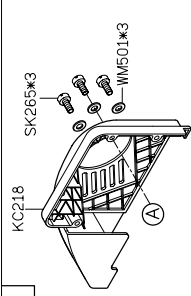

FOR 700KD

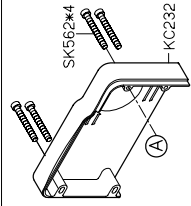

MODEL	3線 / 4線	5線 / 6線
PARTS NO	KC209	KC219

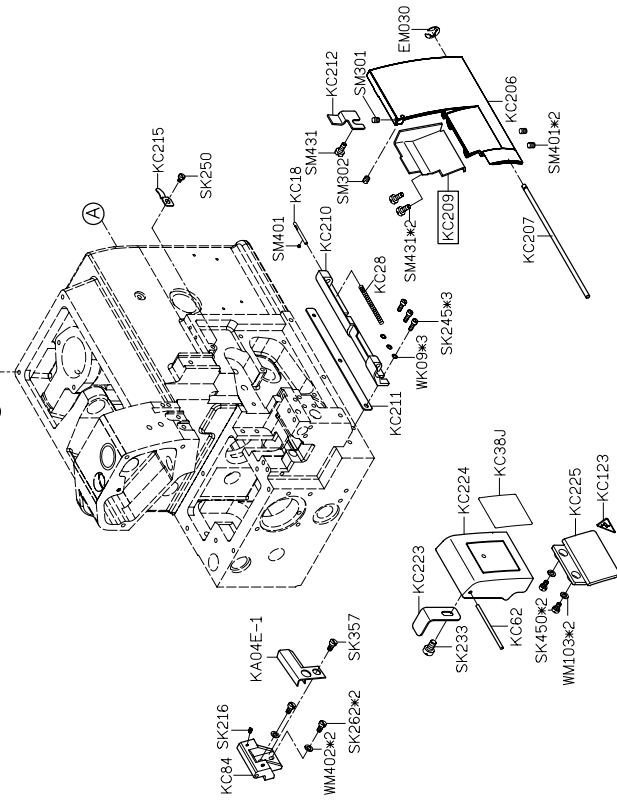
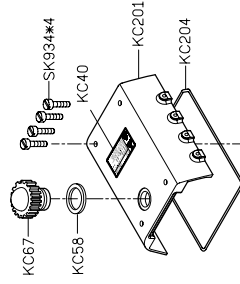

FOR 700K

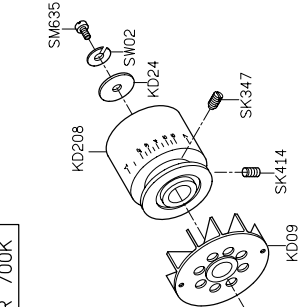

FOR 700KD

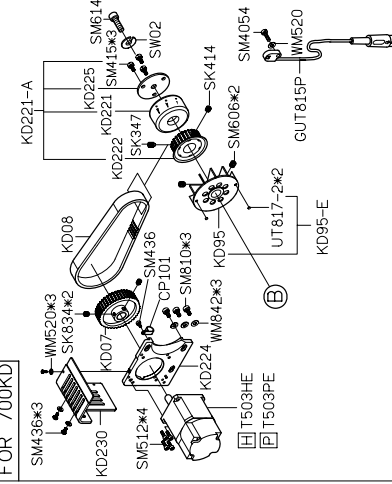

MODEL	3線 / 4線	5線 / 6線
PARTS NO	KD204	KD217
	SM603	KD220
	SK241*3	SK539*2
		SK245*1

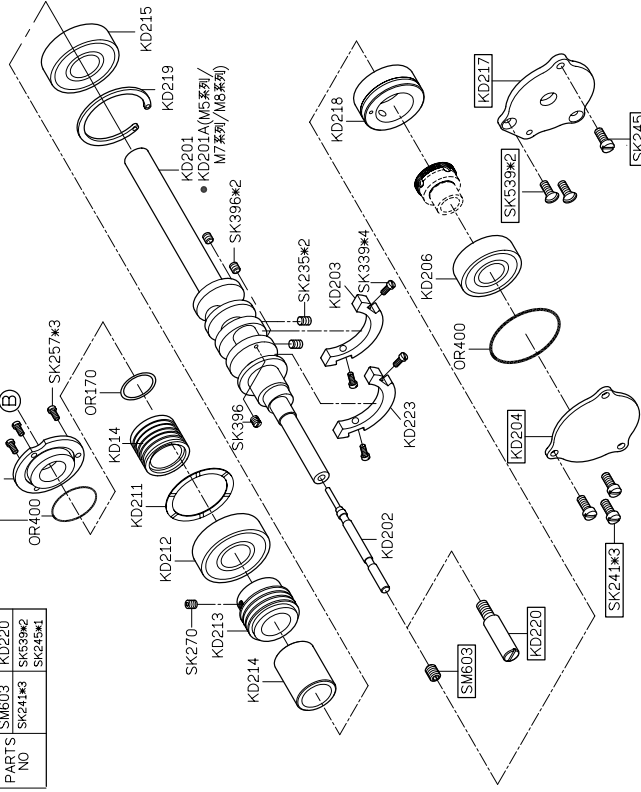

PARTS LIST FOR LD GROUP

PARTS LIST FOR LD GROUP

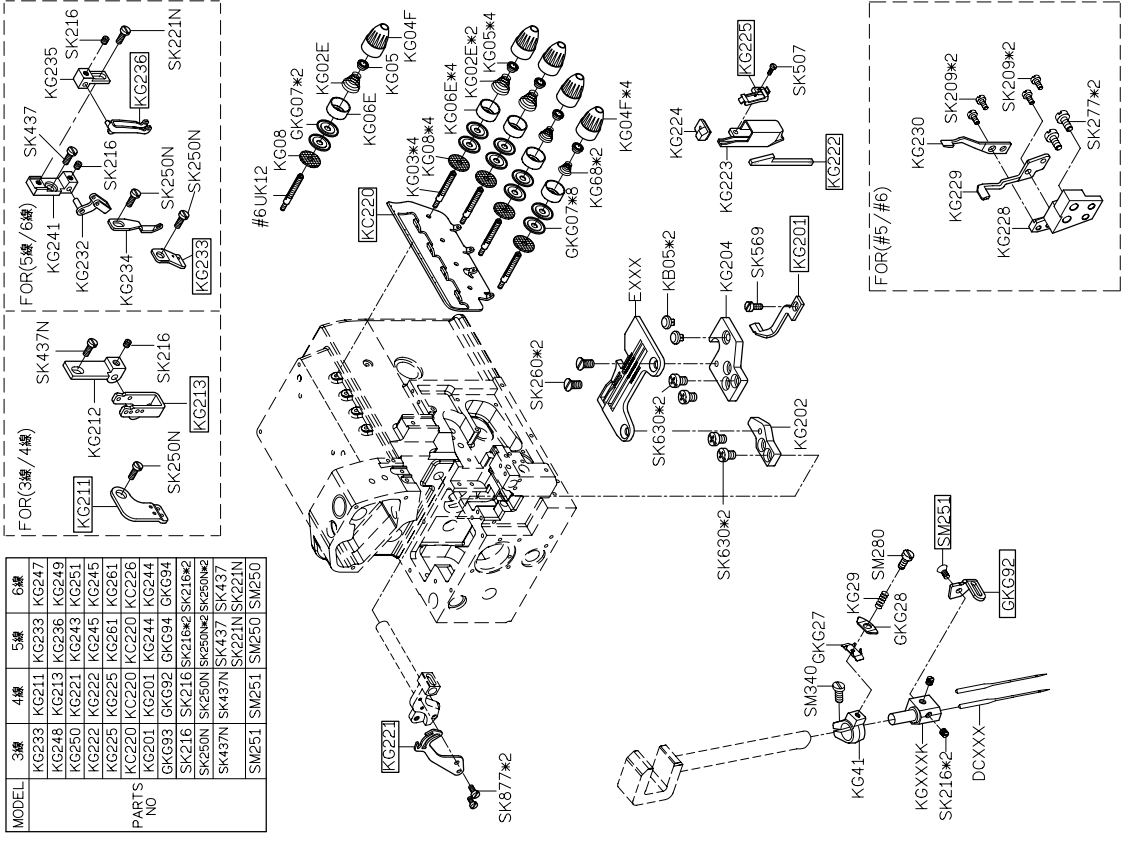
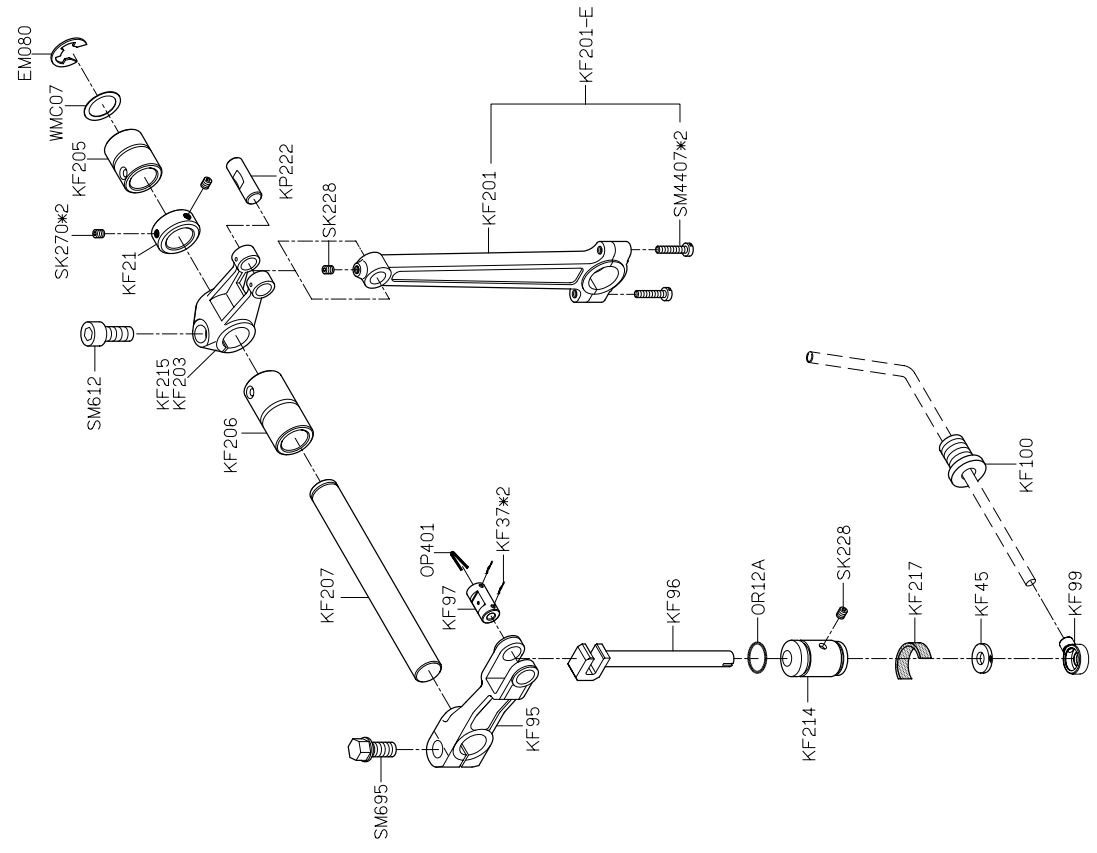

MODEL	3線	4線	5線	6線
	KG233	KG211	KG233	KG247
	KG248	KG213	KG236	KG249
	KG250	KG221	KG243	KG245
	KG222	KG222	KG245	KG245
	KG225	KG225	KG261	KG261
	KG220	KG220	KG220	KG226
	KG201	KG201	KG244	KG244
	KG93	KG92	KG94	KG94
	SK216	SK216	SK216*2	SK216*2
	SK250N	SK250N	SK250N	SK250N
	SK437N	SK437	SK437	SK437
	SK221N	SK221N	SK221N	SK221N
	SM251	SM251	SM250	SM250

PARTS NO

MODEL	3線/5線	4線/5線	4線/6線
PARTS NO	KJ204	KJ234+KL15	KJ234+KL15
	KJ206	KJ203	
	KJ236	KJ208	

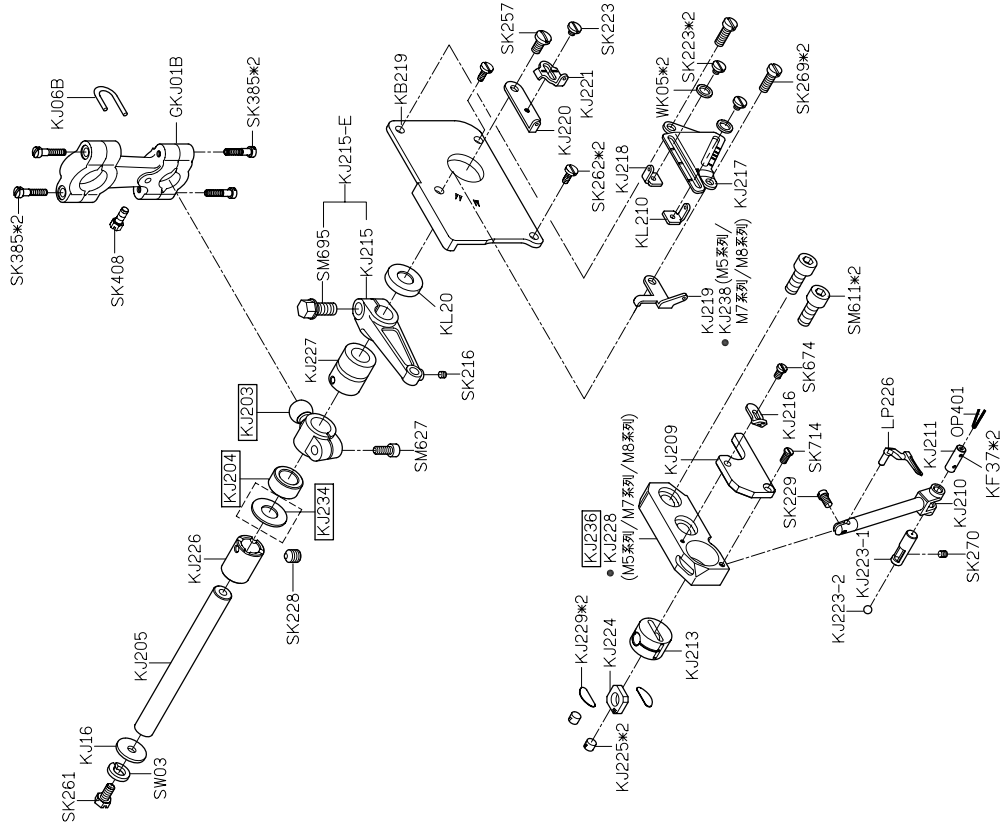

MODEL	3線/4線	5線/6線
PARTS NO	KL205	KL209
		SK270

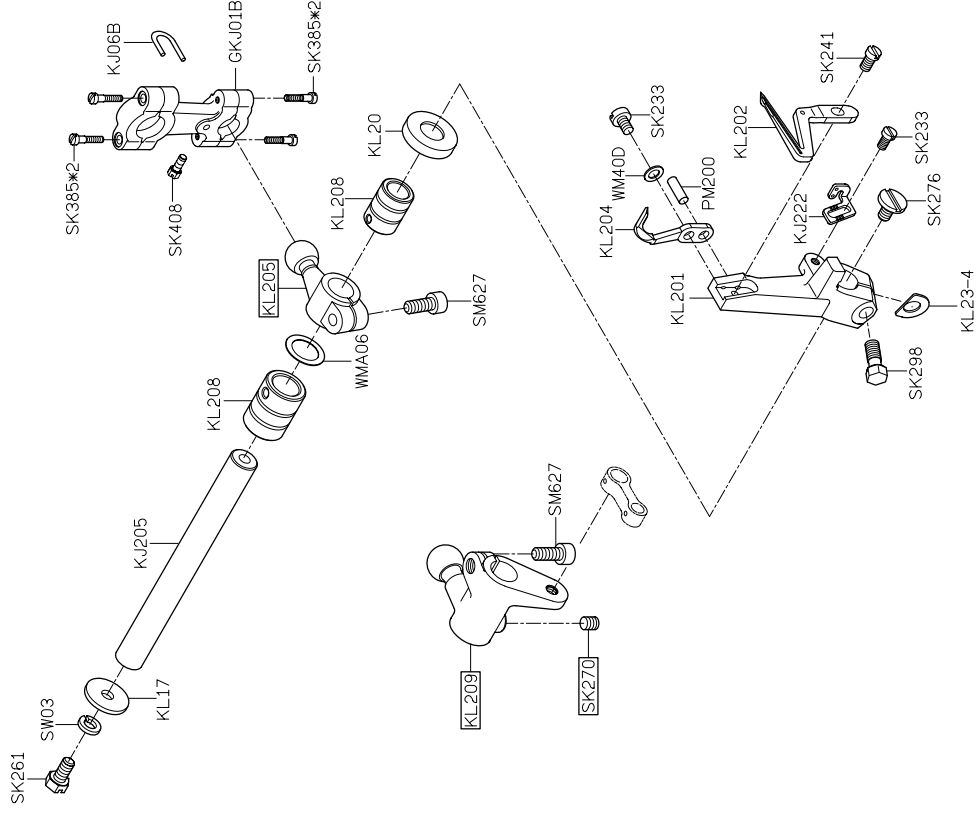





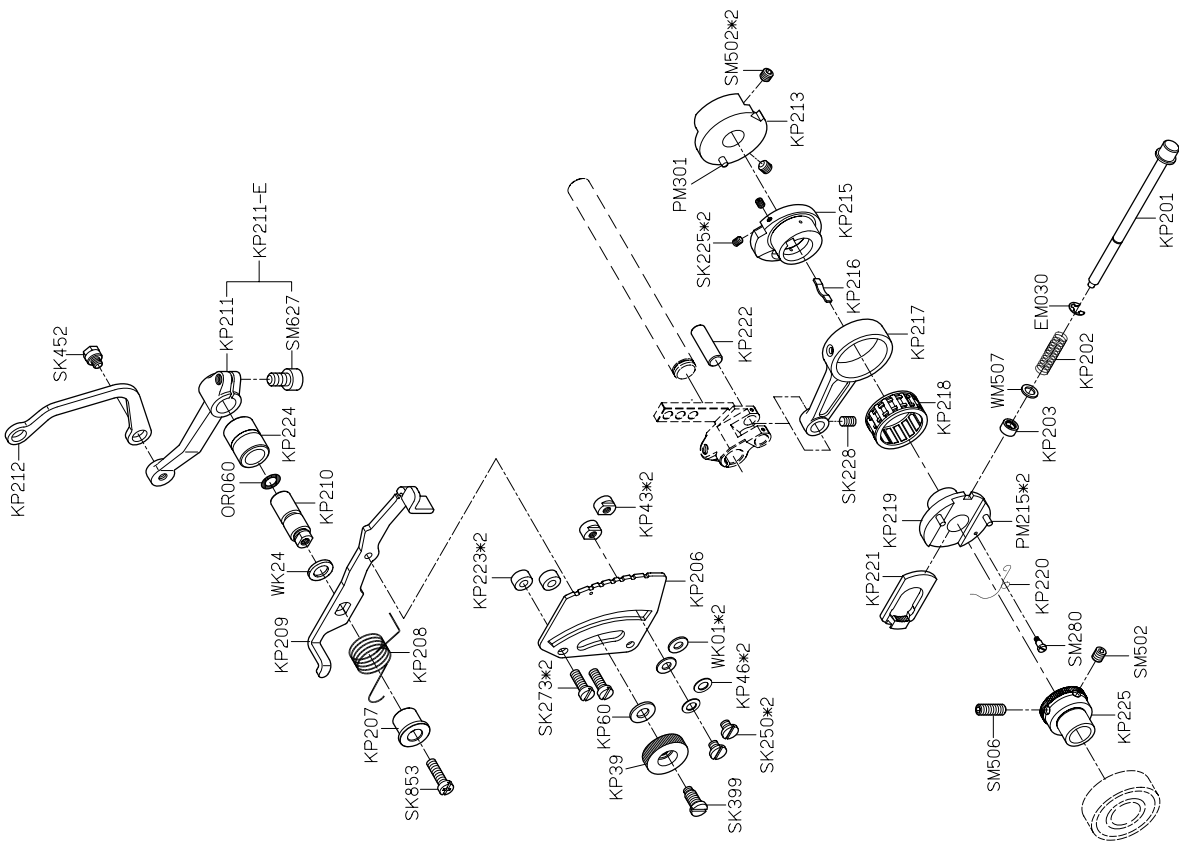

PARTS LIST FOR KP GROUP

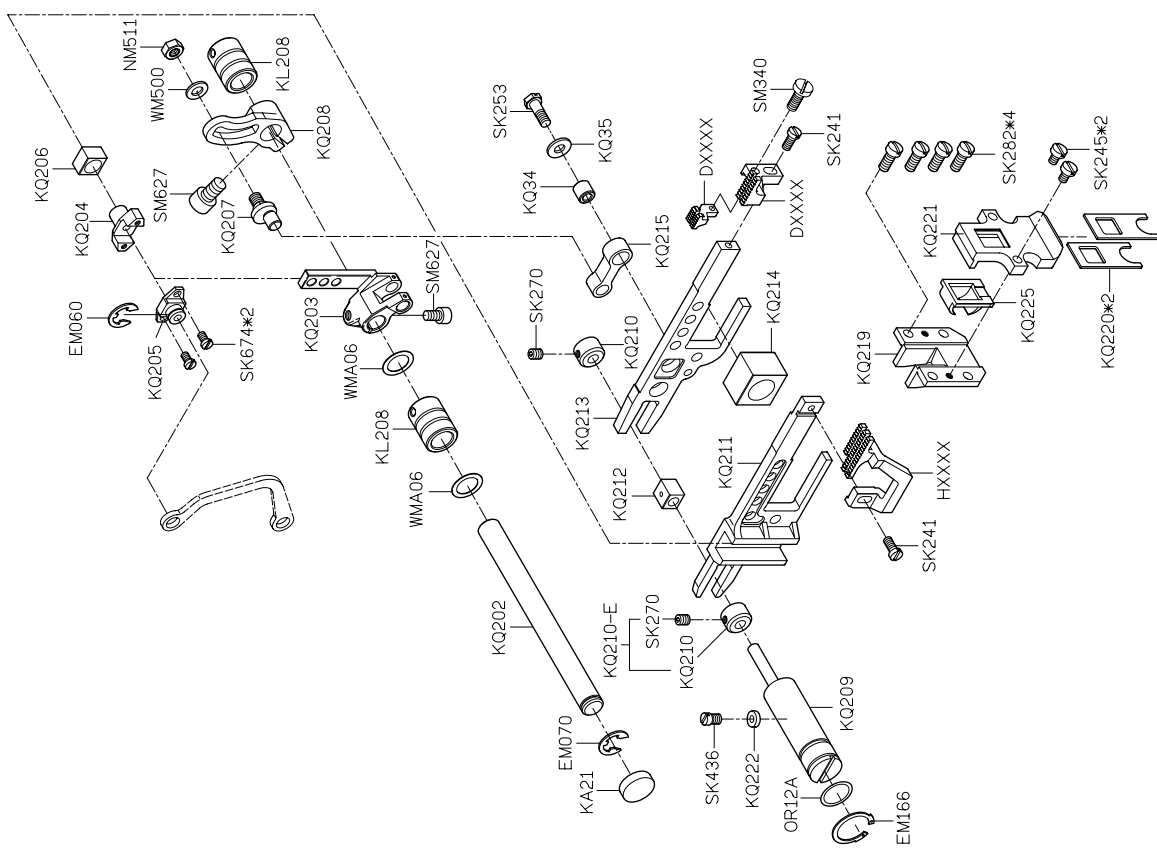

PARTS LIST FOR KQ GROUP

# PARTS LIST FOR KR GROUP

# PARTS LIST FOR KS GROUP

MODEL	3線 / 4線	5線 / 6線
PARTS NO	KR202	KR218
	KR206	KR221
	KR209	KR219

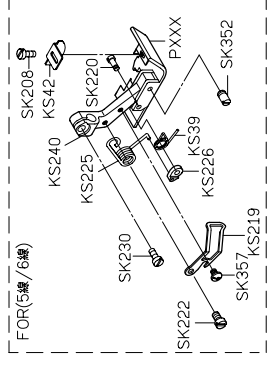
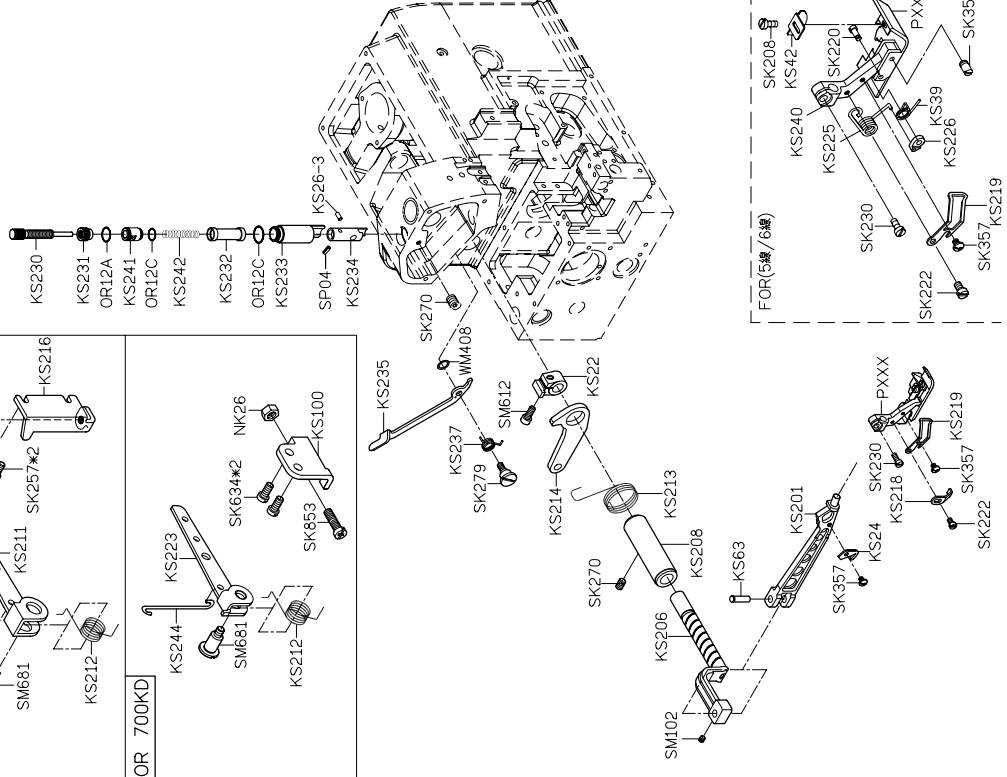
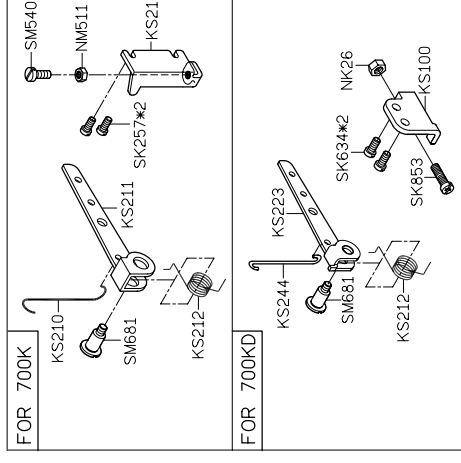
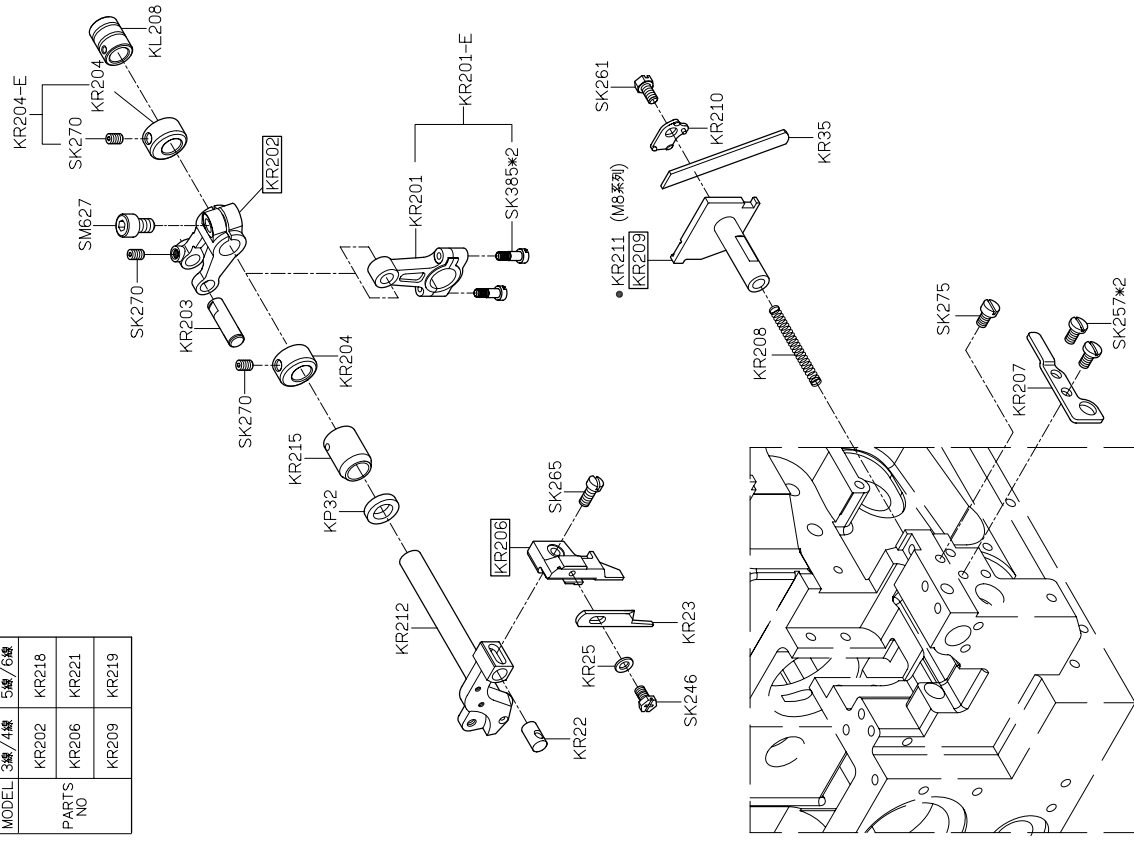

MODEL	3線/4線	5線/6線
PARTS NO	GKU40 KU207 KU206 SK277	GKU39 KU209 KU211 SK437

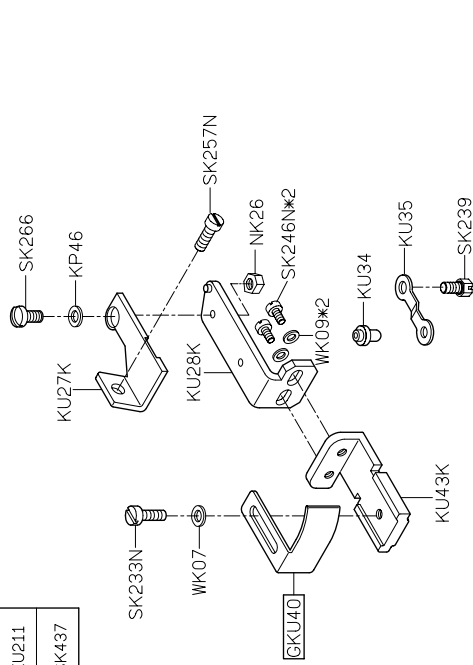
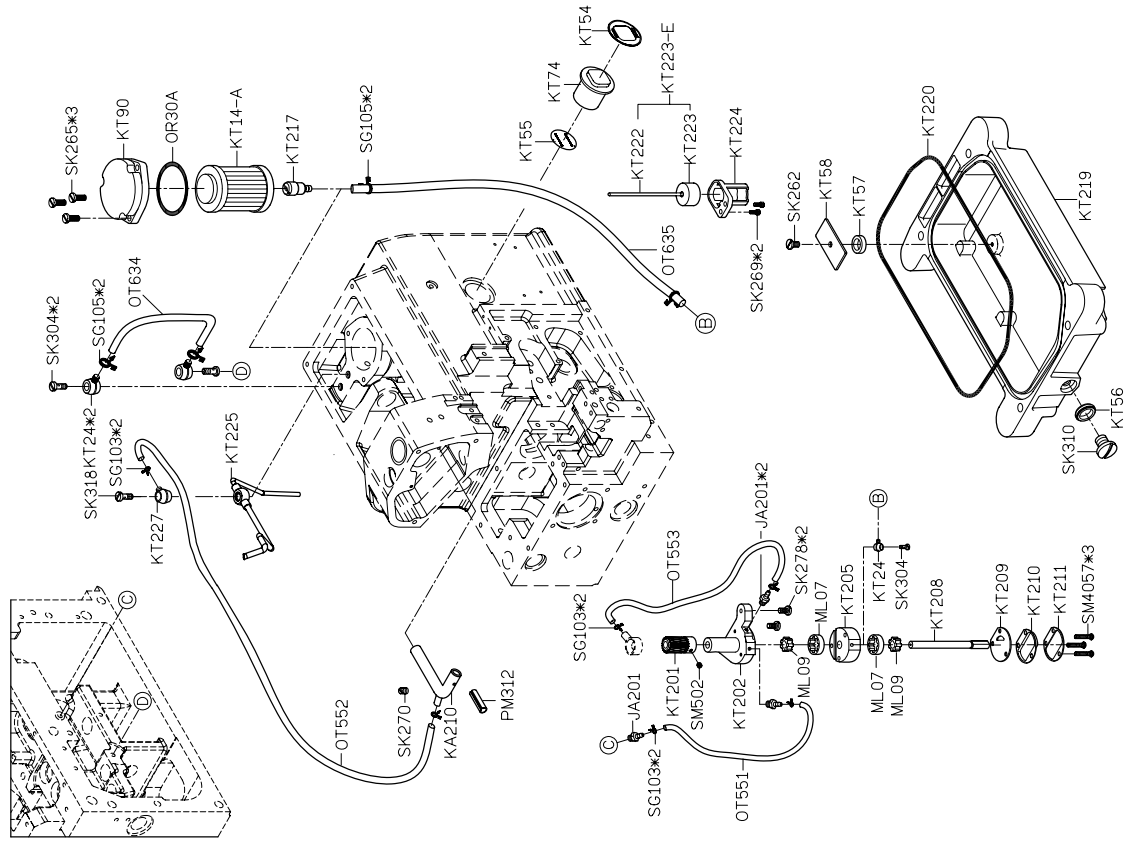

# PARTS LIST FOR KW GROUP

KW40E-3

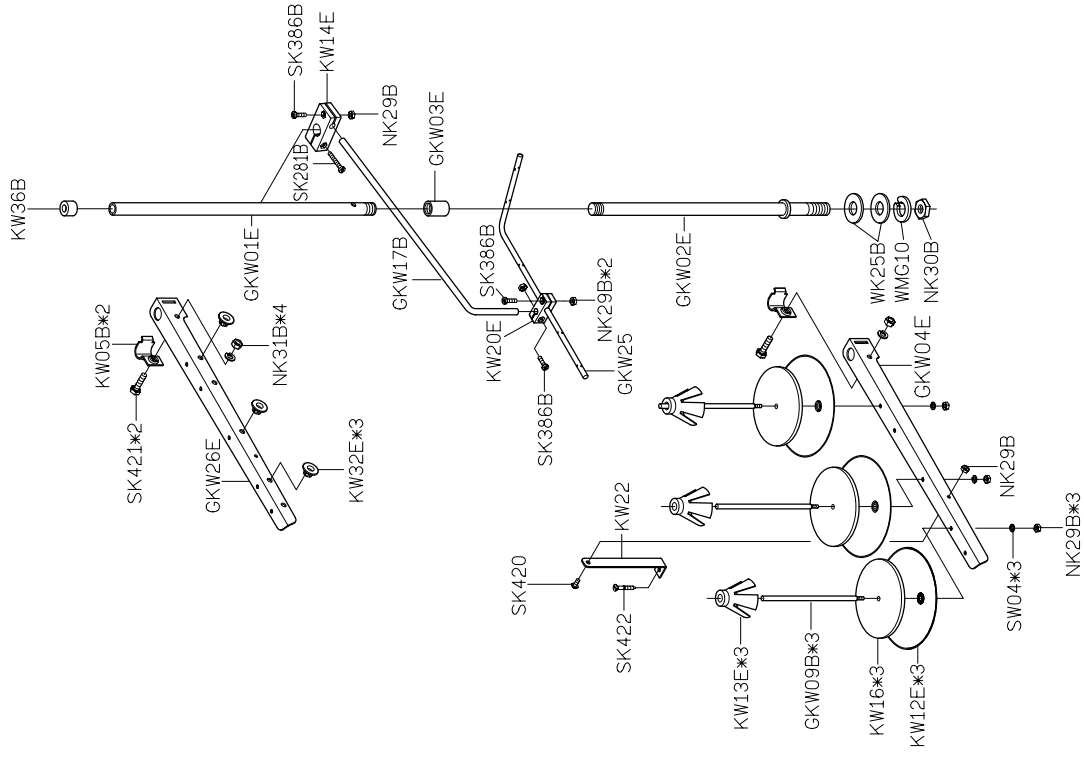

# PARTS LIST FOR KW GROUP

KW40E-4

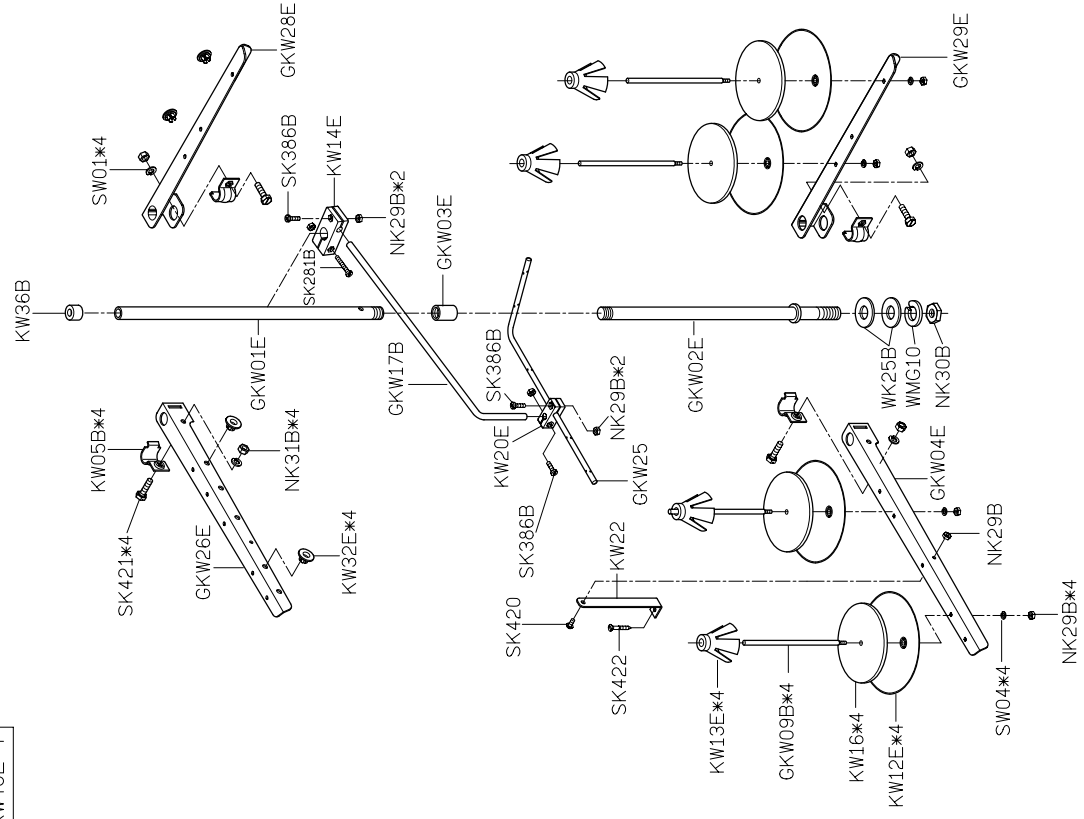



KW40E-5

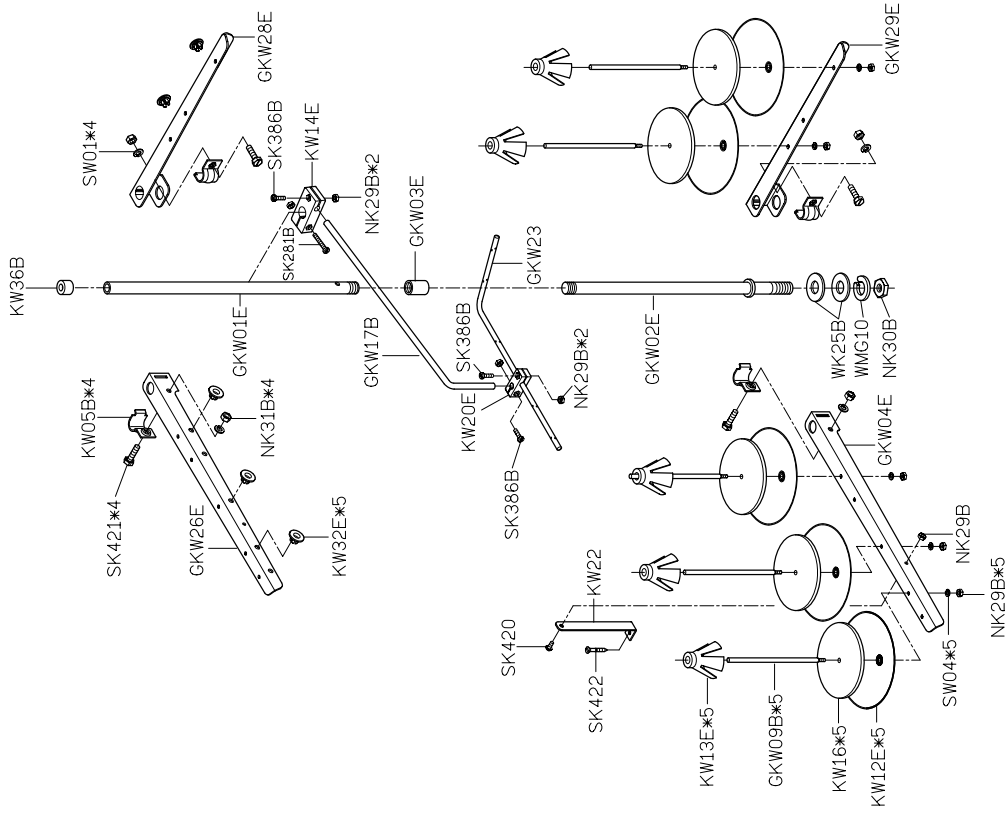



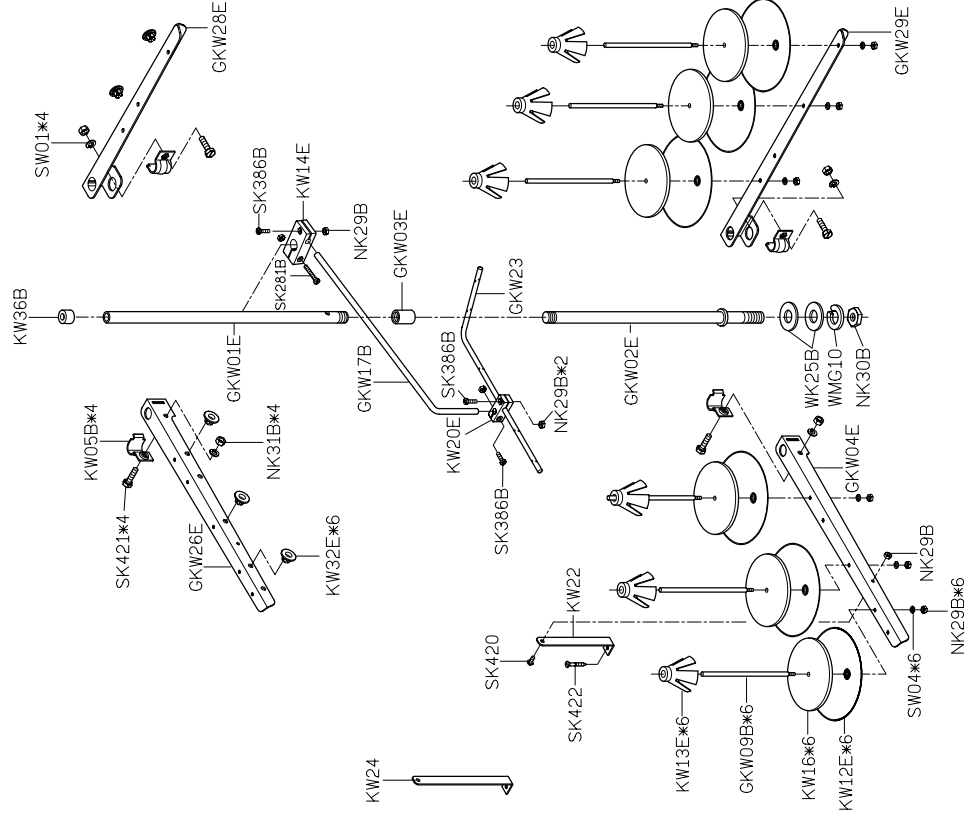



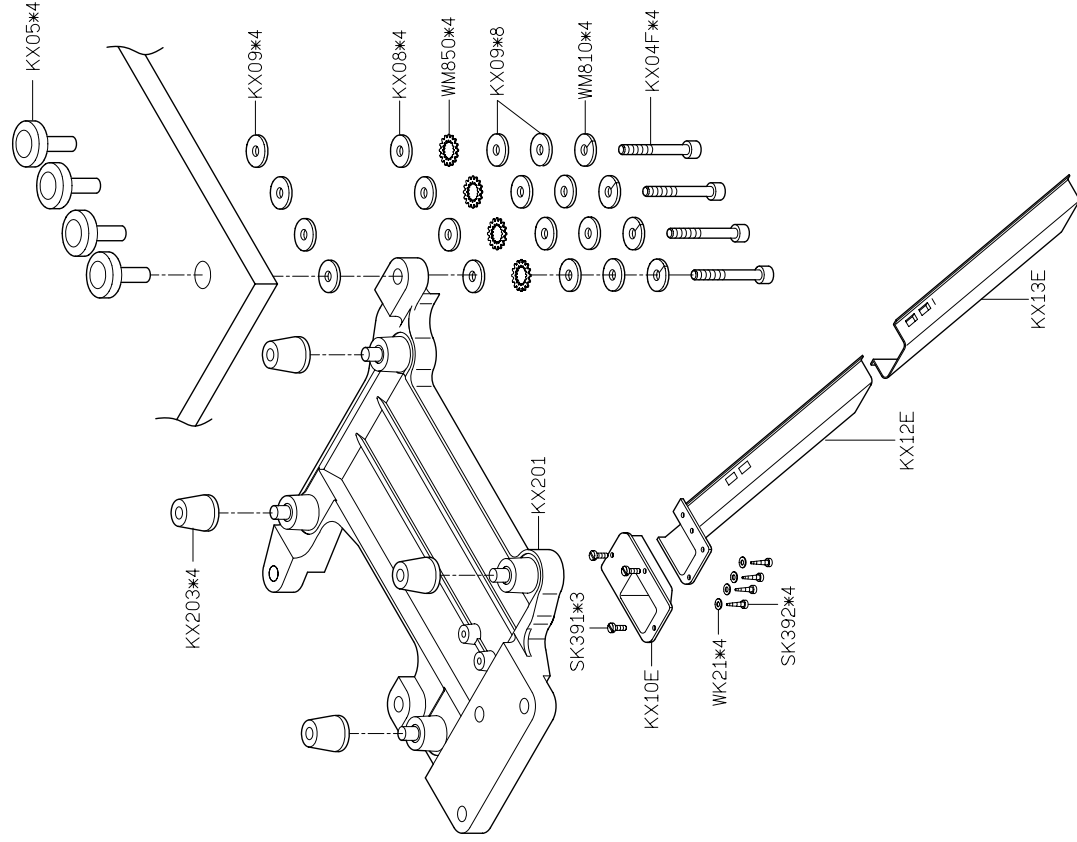



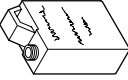
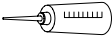









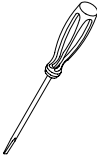

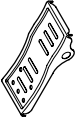

KW40E-6

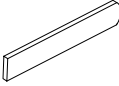

# PARTS LIST FOR KX GROUP



# PARTS LIST FOR KY GROUP

GKY01-1 防塵罩 	KY02F-A 油罐 	KY03 油壺 	KY04 漏斗 	KY05-A 油壺 
KY07 開口板手 	KY08 開口板手 	KY09 開口板手 	KY10 六角板手 	KY11 六角板手 
KY12 六角板手 	KY14 內六角螺絲起子 	KY16 一字起子 	KY17 一字起子 	KY18 鑷子 
KY19 穿線器 	GKY20D 腳踏板 	KY21-A/MY21 鉤子/鍊條 	GKY26F 工具袋 	
KR35 下刀片 	KT14-A 濾油器 	KY30 針板紙 	KZ03 乾燥濟 	針*5 車針 
KZ08J 使用說明書 	KZ08J-2 零件圖 	SK216 螺絲 		

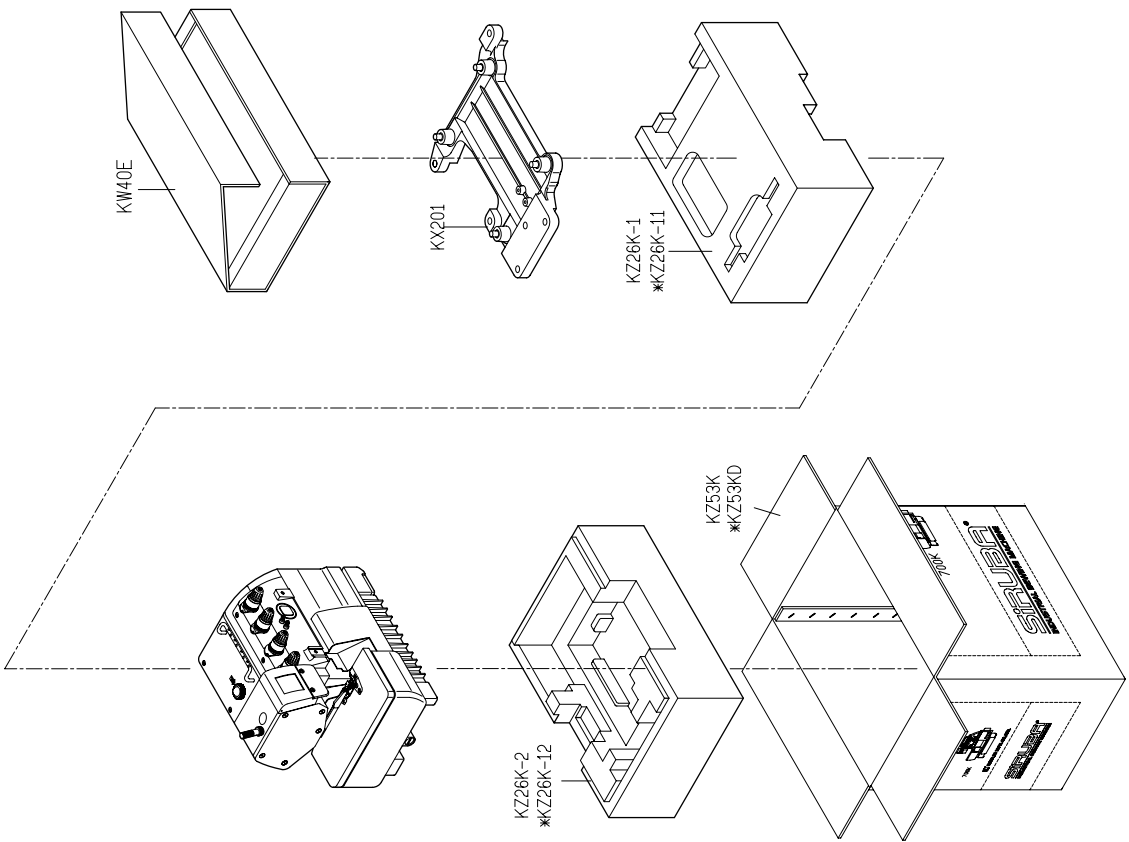

**PARTS LIST FOR KZ GROUP**



# 700K

高林股份有限公司 KAULIN MFG. CO., LTD.